

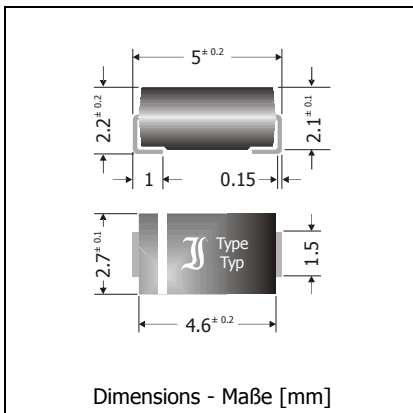

ER1A ... ER1M

Superfast Switching Surface Mount Si-Diodes Superschnelle Si-Dioden für die Oberflächenmontage

Version 2010-03-30



Nominal current – Nennstrom	1 A
Repetitive peak reverse voltage Periodische Spitzensperrspannung	50...1000 V
Plastic case Kunststoffgehäuse	~ SMA ~ DO-214AC
Weight approx. – Gewicht ca.	0.07 g
Plastic material has UL classification 94V-0 Gehäusematerial UL94V-0 klassifiziert	
Standard packaging taped and reeled Standard Lieferform gegurtet auf Rolle	

Maximum ratings

Grenzwerte

Type Typ	Repetitive peak reverse voltage Periodische Spitzensperrspannung V_{RRM} [V]	Surge peak reverse voltage Stoßspitzensperrspannung V_{RSM} [V]
ER1A	50	50
ER1B	100	100
ER1D	200	200
ER1G	400	400
ER1J	600	600
ER1K	800	800
ER1M	1000	1000

Max. average forward rectified current, R-load Dauergrenzstrom in Einwegschaltung mit R-Last	$T_T = 100^\circ\text{C}$	I_{FAV}	1 A
Repetitive peak forward current Periodischer Spitzenstrom	$f > 15\text{ Hz}$	I_{FRM}	6 A ¹⁾
Peak forward surge current, 50 Hz half sine-wave Stoßstrom für eine 50 Hz Sinus-Halbwelle	$T_A = 25^\circ\text{C}$	I_{FSM}	30 A
Rating for fusing, $t < 10\text{ ms}$ Grenzlastintegral, $t < 10\text{ ms}$	$T_A = 25^\circ\text{C}$	i^2t	4.5 A ² s
Junction temperature – Sperrschichttemperatur Storage temperature – Lagerungstemperatur		T_j T_s	-50...+150°C -50...+150°C

1 Max. temperature of the terminals $T_T = 100^\circ\text{C}$ – Max. Temperatur der Anschlüsse $T_T = 100^\circ\text{C}$

Characteristics
Kennwerte

Type Typ	Reverse recovery time Sperrverzugszeit t_{rr} [ns] ¹⁾	Forward voltage Durchlass-Spannung V_F [V] at / bei I_F [A]
ER1A...ER1D	< 35	< 1.0
ER1G	< 35	< 1.25
ER1J...ER1M	< 75	< 1.7

Leakage current Sperrstrom	$T_j = 25^\circ\text{C}$ $V_R = V_{RRM}$ $T_j = 100^\circ\text{C}$ $V_R = V_{RRM}$	I_R I_R	< 5 μA < 300 μA
Thermal resistance junction to ambient air Wärmewiderstand Sperrschicht – umgebende Luft		R_{thA}	< 70 K/W ²⁾
Thermal resistance junction to terminal Wärmewiderstand Sperrschicht – Anschluss		R_{thT}	< 30 K/W

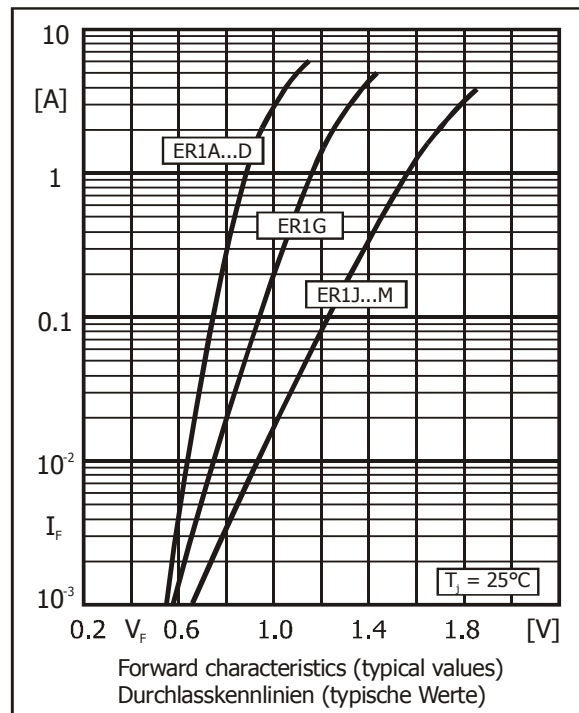
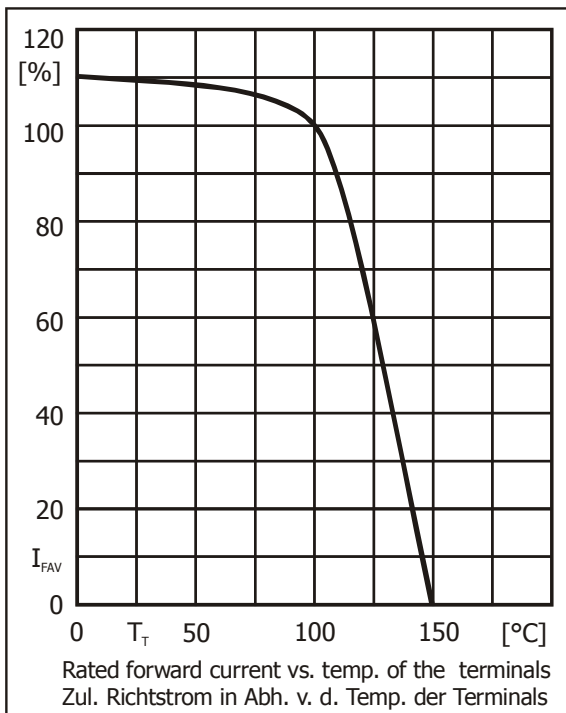

- $I_F = 0.5$ A through/über $I_R = 1$ A to/auf $I_R = 0.25$ A
- Mounted on P.C. board with 25 mm² copper pads at each terminal
Montage auf Leiterplatte mit 25 mm² Kupferbelag (Löt-pad) an jedem Anschluss